

MultiPlus-II GX Inverter/Charger

MultiPlus-II 24/3000/70-32 GX, 48/3000/35-32 GX & 48/5000/70-50 GX

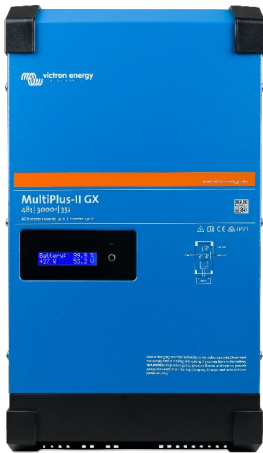

A MultiPlus-II with LCD and GX functionality

The MultiPlus-II GX integrates a MultiPlus-II inverter/charger and a GX device with a 2 x 16 character display.

Display and Wi-Fi

The display reads battery, inverter and solar charge controller parameters.

The same parameters can be accessed with a smartphone or other Wi-Fi enabled device.

GX device

The integrated GX device includes:

- A BMS-Can interface. This can be used to connect to a compatible CAN-bus managed battery. Note that this not a VE.Can compatible port.
- A USB port.
- A Ethernet port.
- A VE.Direct port.

Applications

The MultiPlus-II GX is intended for applications where additional interfacing with other products and/or remote monitoring is required, such as on-grid or off-grid energy storage systems and certain mobile applications.

Parallel and three phase operation

Only one GX unit is needed in case of Parallel and three phase operation.

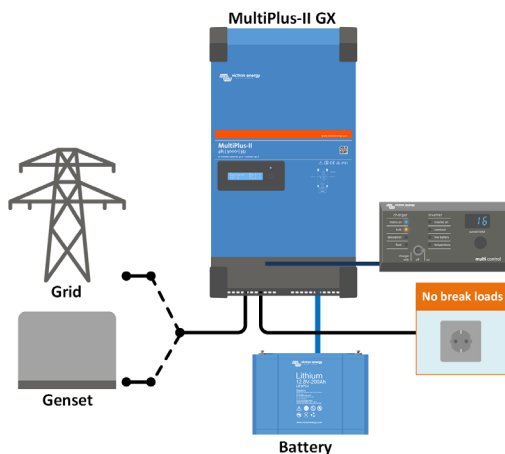

Standard marine, mobile or off-grid application

Loads that should shut down when AC input power is not available can be connected to a second output (not shown). These loads will be taken into account by the PowerControl and PowerAssist function in order to limit AC input current to a safe value when AC power is available.

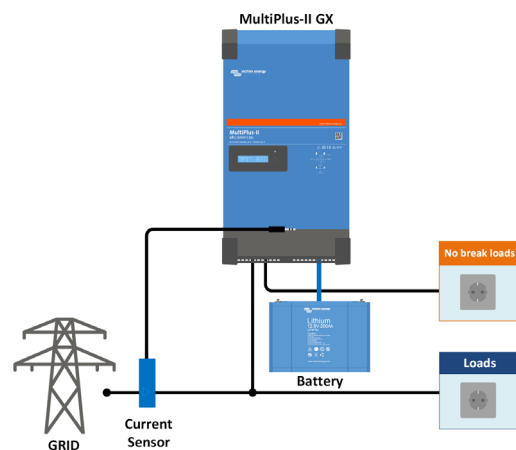

Standard mobile or off-grid application with external current sensor

Maximum current sensing range: 50 A resp 100 A

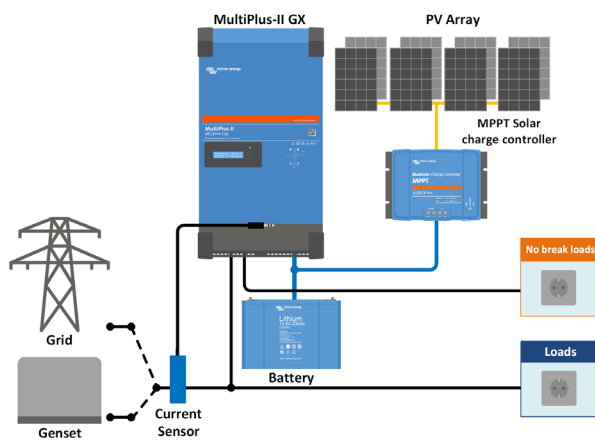

Grid parallel topology with MPPT solar charge controller

The MultiPlus-II will use data from the external AC current sensor (must be ordered separately) or power meter to optimise self-consumption and, if required, to prevent grid feed. In case of a power outage, the MultiPlus-II will continue to supply the critical loads

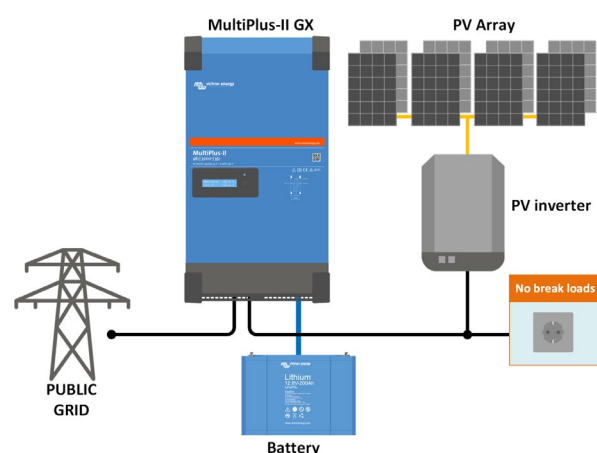

Grid in-line topology with PV inverter

PV power is directly converted to AC.

The MultiPlus-II will use excess PV power to charge the batteries or to feed power back into the grid, and will discharge the battery or use power from the grid to supplement a shortage of PV power. In case of a power outage, the MultiPlus-II will disconnect the grid and continue to supply the loads.



VRM Portal

Our free remote monitoring website (VRM) will display all your system data in a comprehensive graphical format. System settings can be changed remotely via the portal. Alarms can be received by e-mail.



VRM app for Wi-Fi

Monitor and manage your Victron Energy system from your smart phone and tablet. Available for both iOS and Android.



GX GSM

A cellular modem; providing a mobile internet for the system and connection to Victron Remote Management (VRM).
Optional: outdoor GSM antenna and GPS antenna.
For more detail please enter *GX GSM* in the search box on our website



Connection Area



Current sensor 100 A:50 mA

To implement PowerControl and PowerAssist and to optimize self-consumption with external current sensing.
Maximum current: 50 A resp. 100 A.
Length of connection cable: 1 m.



Digital Multi Control Panel

A convenient and low-cost solution for remote monitoring, with a rotary knob to set PowerControl and PowerAssist levels.

MultiPlus-II GX	24/3000/70-32	48/3000/35-32	48/5000/70-50
PowerControl & PowerAssist	Yes		
Transfer switch	32 A	50 A	
Maximum AC input current	32 A		
Auxiliary output	Yes (32 A)		
INVERTER			
DC Input voltage range	19 – 33 V	38 – 66 V	
Output	Output voltage: 230 VAC ± 2 % Frequency: 50 Hz ± 0,1 % (1)		
Cont. output power at 25 °C (3)	3000 VA	5000 VA	
Cont. output power at 25 °C	2400 W	4000 W	
Cont. output power at 40 °C	2200 W	3700 W	
Cont. output power at 65 °C	1700 W	3000 W	
Maximum apparent feed-in power	3000 VA	5000 VA	
Peak power	5500 W	9000 W	
Maximum efficiency	94 %	95 %	96 %
Zero load power	13 W	11 W	18 W
Zero load power in AES mode	9 W	7 W	12 W
Zero load power in Search mode	3 W	2 W	2 W
CHARGER			
AC Input	Input voltage range: 187-265 VAC Input frequency: 45 – 65 Hz		
Charge voltage 'absorption'	28,8 V	57,6 V	
Charge voltage 'float'	27,6 V	55,2 V	
Storage mode	26,4 V	52,8 V	
Maximum battery charge current (4)	70 A	35 A	70 A
Battery temperature sensor	Yes		
GENERAL			
Interfaces	BMS-Can, USB, Ethernet, VE.Direct, Wi-Fi		
External AC current sensor (optional)	50 A	100 A	
Programmable relay (5)	Yes		
Protection (2)	a – g		
VE.Bus communication port	For parallel and three phase operation, remote monitoring and system integration		
General purpose com. port	Yes, 2x		
Remote on-off	Yes		
Operating temperature range	-40 to +65 °C (fan assisted cooling)		
Humidity (non-condensing)	max 95 %		
ENCLOSURE			
Material & Colour	Steel, blue RAL 5012		
Protection category	IP22		
Battery-connection	M8 bolts		
230 V AC-connection	Screw terminals 13 mm ² (6 AWG)		
Weight	19 kg	30 kg	
Dimensions (h x w x d) mm	506 x 275 x 147	565 x 323 x 148	
STANDARDS			
Safety	EN-IEC 60335-1, EN-IEC 60335-2-29, EN-IEC 62109-1, EN-IEC 62109-2		
Emission, Immunity	EN 55014-1, EN 55014-2 EN-IEC 61000-3-2, EN-IEC 61000-3-3 IEC 61000-6-1, IEC 61000-6-2, IEC 61000-6-3		
Uninterruptible power supply	IEC 62040-1		
Anti-islanding	Please consult the certificates on our website.		
1) Can be adjusted to 60 Hz	3) Non-linear load, crest factor 3:1		
2) Protection key:	4) At 25 °C ambient		
a) output short circuit	5) Programmable relay which can be set for general alarm, DC under voltage or genset start/stop function.		
b) overload	AC rating: 230 V / 4 A, DC rating: 4 A up to 35 VDC and 1 A up to 60 VDC		
c) battery voltage too high			
d) battery voltage too low			
e) temperature too high			
f) 230 VAC on inverter output			
g) input voltage ripple too high			